

Hänsch[®]///

CATALOGUE



ENGLISH

Table of content

Inquiries

...please send to the following email address: sales@fg-haensch.de

Purchase orders

...please send to the following email address: sales@fg-haensch.de

Further information

"Blue light" applications



"Amber" applications



Cable assembly



Working lights



LED beacons	Pages 2 - 18
HT solutions	Pages 19 - 23
Lightbar systems	Pages 24 - 45
Control units	Pages 46 - 50
Integrated solutions	Pages 51 - 52
Rear warning systems (RWS)	Pages 53 - 55
Sputnik Hybrid	Page 56
Sputnik Flat	Page 57
Sputnik mini	Page 58
MOWACOM 2	Pages 59 - 60
Airport	Pages 61 - 67
Cable assembly	Page 68
Service	Page 69
Glossary	Pages 70 - 72
Contact	Page 73

LED beacons



LED beacons

- Efficient
- Powerful
- Flexible
- Long-lasting

Our LED beacons can be used flexibly in every area of application. Different mounting and size variants enable an assembly for every class of vehicle. Long-lasting, low power consumption and high electromagnetic compatibility characterise our LED beacons.

Model size comparison



COMET S / SR

Example vehicle type:
Car

COMET

Example vehicle type:
Car

SATURN

Example vehicle type:
Van/dropsider

NOVA

Example vehicle type:
Truck

MOVIA - SL

Example vehicle type:
Car

COMET S

Overview of options

Whether fixed mounting, tube mounting or magnetic fixing – the various versions of the COMET S LED beacon offer a solution for every requirement. Our COMET S has an impressively extra flat and modern design. Maximum light intensity (Class II homologation) and a fully lighted lamp dome ensure the best possible visibility and warning effect.



Fix mounting



Magnetic fixing



Tube mounting

Fix mounting

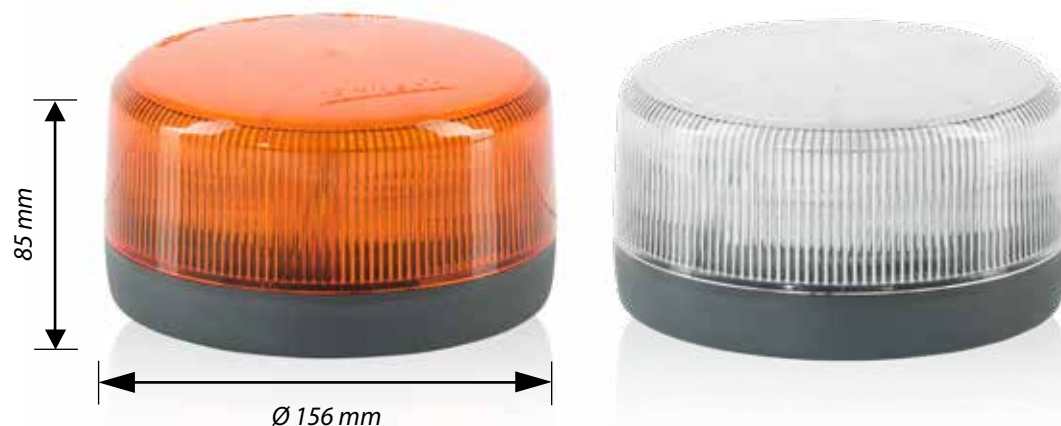

Also available with examination in accordance with ICAO type C. Further information can be found on page 62.

PRODUCT FEATURES:

- suitable for cars
- fix mounting according to DIN 14620, form B1
- various homologated flash patterns integrated
- two rows of LEDs provide full-area illumination
- class II homologation
- compensating wedge available for mounting on sloping surfaces
- options:
 - day/night switching (via cable) in the version with amber lamp dome
 - day/night switching (automatic) in the version with amber lamp dome
 - convoy function
 - function monitoring
 - analogue or CiA447 version
 - also available with clear lamp dome
 - soft light signal (night) possible
- colours: also available in blue, red and green

<i>Technical data:</i>	
Designation:	COMET S
Voltage:	12 V / 24 V multi-voltage
Flash frequency:	> 2 Hz
Average power consumption:	12 V: 1.3 A / 24 V: 0.7 A
Material:	lamp dome: PC / socket: ASA
Type of protection:	IP5K4K / IPX9K
<i>Homologation: (Germany and international)</i>	
Light according to ECE-R 65:	TA2 (E1) 00 4426 / TA1 (E1) 00 4591
EMC according to ECE-R 10:	(E1) 10R-05 7965

COMET S

Magnetic fixing



PRODUCT FEATURES:

- suitable for cars
- with spiral cable and triple magnetic fixing
- optimum adhesion, even on curved vehicle roofs
- rubber-coated magnets protect paintwork against scratches
- tested at up to 250 km/h
- analogue control
- various homologated flash patterns integrated
- two rows of LEDs provide full-area illumination
- options:
 - day/night switching (automatic) in the version with amber lamp dome
 - also available with clear lamp dome
 - soft light signal (night) possible
 - analogue or CiA447 version
- colours: also available in blue and red

Tube mounting



PRODUCT FEATURES:

- suitable for cars
- for fitting on a mounting tube in accordance with DIN 14620
- impact-resistant housing base
- various homologated flash patterns integrated
- two rows of LEDs provide full-area illumination
- mating part available in different versions
- options:
 - day/night switching (automatic) in the version with amber lamp dome
 - flexible (AF) or fixed tube (A)
 - also available with clear lamp dome
 - soft light signal (night) possible
- colours: also available in blue and red

Both versions are also available with examination in accordance with ICAO type C. Further information can be found on page 62.

Hänsch®///

• New light technology with more LEDs and rotating light function – in the housing of the Comet S

The very best equipment with conspicuous warning systems is very important for ensuring safety and protection at work, particularly for municipal vehicles used by highway depots, maintenance depots and local authority services. Our COMET SR impresses not only with its flat and modern design, but also because of the highest possible geometric visibility and warning effect from the rotating light (homologated according to ECE-R 65). Whenever rotating light is required, our COMET SR is the best solution for keeping both the site and the workers safe.



PRODUCT FEATURES:

- suitable for cars
- compact plastic housing
- two rows of LEDs ensure a high warning effect
- flash pattern: possibility to switch between rotating light and strobe light (analogue)
- function monitoring
- compensating wedge available for mounting on sloping surfaces
- options:
 - fix mounting, tube mounting or magnetic fixing
 - analogue or CiA447 version
 - also available with clear lamp dome
- colours: also available in blue

Technical data:	
Designation:	COMET SR
Voltage:	12 V / 24 V multi-voltage
Flash frequency:	> 2 Hz
Average power consumption:	12 V: 1.3 A / 24 V: 0.7 A
Material:	lamp dome: PC / socket: ASA
Type of protection:	IP5K4K / IPX9K
Homologation: (Germany and international)	
Light according to ECE-R 65:	TA1(E1) 00 5170 / TA1(E1) 00 5171
EMC according to ECE-R 10:	(E1)10R-06 9004



Comet SR video

COMET LED

Overview of options

Whether fix mounting, tube mounting or magnetic fixing – the various versions of the COMET LED beacon offer a solution for every requirement. Our COMET LED beacons are distinguished by powerful LED technology with an outstanding warning effect integrated in a compact housing.



Fix mounting



Magnetic fixing



Tube mounting

Fix mounting



PRODUCT FEATURES:

- suitable for cars
- fix mounting according to DIN 14620, form B1
- compensating wedge available for mounting on sloping surfaces
- options:
 - function monitoring (low or high)
 - analogue or CiA447 version
- colours: also available in blue, red, green and blue/amber

Magnetic fixing



PRODUCT FEATURES:

- suitable for cars
- with spiral cable and triple magnetic fixing
- optimum adhesion, even on curved vehicle roofs
- rubber-coated magnets protect paintwork against scratches
- tested at up to 250 km/h
- colours: also available in blue, red, green and blue/amber



Car plug

Both versions are also available with ICAO type C conformity. Further information can be found on page 62.

COMET LED

Tube mounting



Also available in a version conforming to ICAO type C.
Further information can be found on page 62.

PRODUCT FEATURES:

- suitable for cars
- for fitting on a mounting tube in accordance with DIN 14620
- impact-resistant housing base
- mating part available in different versions
- options:
 - flexible (AF) or fix (A) tube
- colours: also available in blue, red and green

Technical data:

Designation:	COMET LED
Voltage:	12 V / 24 V multi-voltage
Flash frequency:	> 2 Hz
Average power consumption:	12 V: 1.5 A / 24 V: 0.75 A
Material:	lamp dome: PC / socket: ASA
Type of protection:	IP5K4K / IPX9K
Homologation: (Germany and international)	
Light according to ECE-R 65:	TA1 (E1) 00 2872
EMC according to ECE-R 10:	(E1) 10R-06 5669

The SATURN LED beacon is available with either fix mounting or tube mounting options and can thus be used in a wide variety of applications. Our LED beacons are distinguished by powerful LED technology with an outstanding warning effect, integrated in a sturdy housing.

Fix mounting

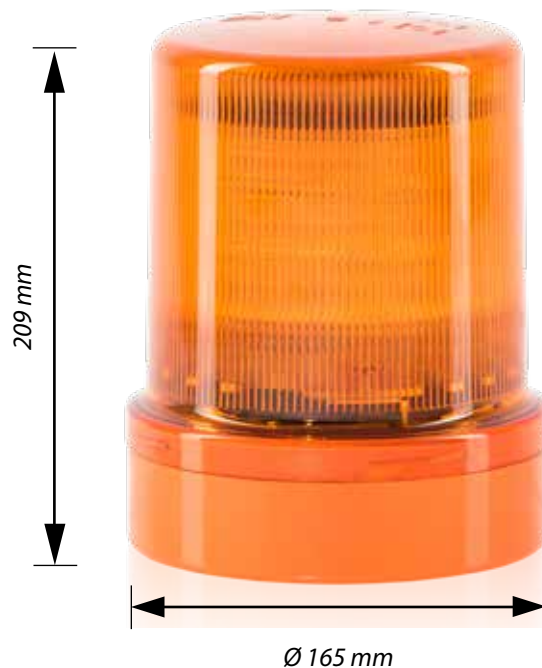

PRODUCT FEATURES:

- suitable for vans/dropsiders
- fix mounting according to DIN 14620, form B1
- function monitoring (low or high)
- colours: also available in blue and red

Tube mounting



PRODUCT FEATURES:

- suitable for vans/dropsiders
- for fitting on a mounting tube in accordance with DIN 14620
- impact-resistant housing base
- mating part available in different versions
- option:
 - flexible (AF) or fixed tube (A)
- colours: also available in blue and red

<i>Technical data:</i>	
Designation:	SATURN LED
Voltage:	12 V / 24 V multi-voltage
Flash frequency:	> 2 Hz
Average power consumption:	12 V: 1.5 A / 24 V: 0.75 A
Material:	lamp dome: PC / socket: ASA
Type of protection:	IP5K4K / IPX9K
<i>Homologation: (Germany and international)</i>	
Light acc. to ECE-R 65:	TA1 (E1) 00 3000
EMC acc. to ECE-R 10:	(E1) 10R-06 5669

NOVA in LED technology

The NOVA in LED technology is the “big sister” of our beacons. Optimal light distribution is generated through the use of high-power LEDs. The NOVA in LED technology is mainly used for large vehicles..

Fix mounting

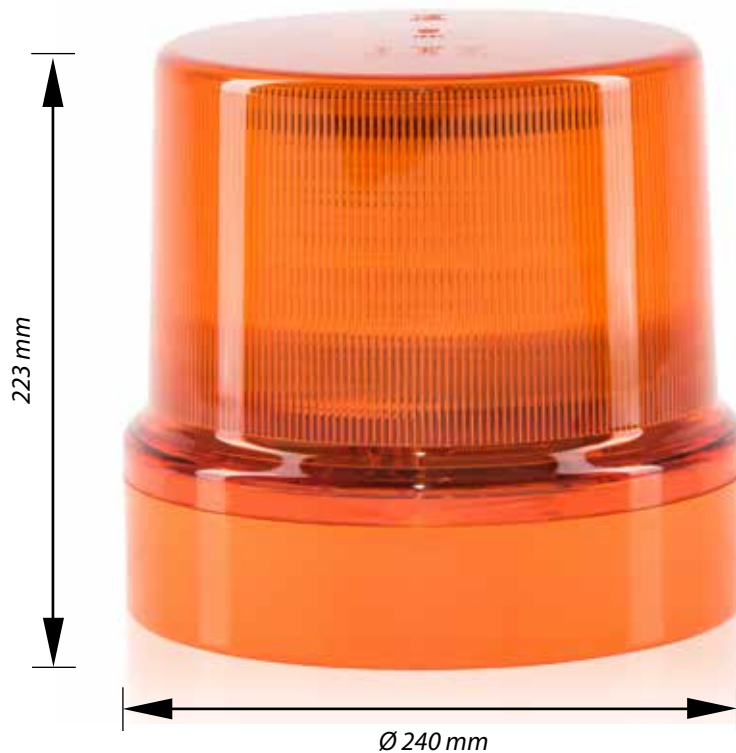

PRODUCT FEATURES:

- suitable for trucks
- fix mounting according to DIN 14620, form B2
- analogue control
- compensating wedge available for mounting on sloping surfaces
- options:
 - function monitoring (low or high)
- colours: also available in blue and red

Technical data:	
Designation:	NOVA-L
Voltage:	12 V / 24 V multi-voltage
Flash frequency:	> 2 Hz
Average power consumption:	12 V: 1.5 A / 24 V: 0.75 A
Material:	lamp dome: PC / socket: ASA
Type of protection:	IP5K4K / IPX9K
Homologation: (Germany and international)	
Light according to ECE-R 65:	TA1 (E1) 00 2916
EMC according to ECE-R 10:	(E1) 10R-06 5669

Overview of options

Whether fix mounting, tube mounting or magnetic fixing – the various versions of the MOVIA - SL LED beacon offer a solution for any application. Our MOVIA - SL LED beacons feature powerful LED technology with excellent warning signals, packed into a compact housing.



Magnetic fixing



Tube mounting



Fix mounting

MOVIA - SL

Fix mounting



PRODUCT FEATURES:

- suitable for cars
- options:
 - function monitoring
 - analogue or CiA447 version
- colours: also available in red, blue and blue/amber

Tube mounting



PRODUCT FEATURES:

- suitable for cars
- for fitting on a mounting tube in accordance with DIN 14620
- flexible tube
- mating part available in different versions
- option:
 - also available on telescopic tube
- colours: also available in red and blue

Magnetic fixing



PRODUCT FEATURES:

- suitable for cars
- LED beacon with spiral cable and triple magnetic fixing
- optimum adhesion, even on curved vehicle roofs
- rubber-coated magnets protect paintwork against scratches
- choice of different plugs
- tested up to 270 km/h
- analogue
- colours: also available in blue, blue/amber and red
- protective cover optionally available (soft or synthetic leather)
- built-in socket available for metal elbow plug
- also available with special/strong magnets
- also available with catching lug

<i>Technical data:</i>	
Designation:	MOVIA - SL
Voltage:	12 V / 24 V multi-voltage
Flash frequency:	> 2 Hz
Average power consumption:	12 V: 1.6 A / 24 V: 0.9 A
Material:	housing: aluminium / lamp dome: PC
Type of protection:	IP5K4K / IPX9K
<i>Homologation: (Germany and international)</i>	
Light according to ECE-R 65:	TA1 (E1) 00 3139
EMC according to ECE-R 10:	(E1) 10R-06 5669

Bicoloured LED beacons

switchable between blue and amber

The bicoloured MOVIA - SL and COMET LED beacons are switchable between blue and amber. The blue warning signal is used to indicate the right of way when travelling to the destination. The beacon can be switched to amber at the destination in order to act as a warning signal to secure the area.



Fig. MOVIA - SL

Technical data:		
Designation:	MOVIA - SL	COMET LED
Voltage:	12 V / 24 V multi-voltage	12 V / 24 V multi-voltage
Flash frequency:	> 2 Hz	> 2 Hz
Average power consumption:	12 V: 1.5 A / 24 V: 0.8 A	12 V: 1.5 A / 24 V: 0.75 A
Material:	housing: aluminium / lamp dome: PC	lamp dome: PC / socket: ASA
Type of protection:	IP5K4K / IPX9K	IP5K4K / IPX9K
Homologation: (Germany and international)		
Light according to ECE-R 65:	TB1/TA1 (E1) 00 3139 / TB2 (E1) 00 3140	TB1/TA1 (E1) 00 2872 / TB2 (E1) 00 2814
EMC according to ECE-R 10:	(E1)10R-06 5669	(E1)10R-06 5669

MOVIA - SL and COMET LED VERSIONS

- fix mounting: colour switching via signal line
- magnetic fixing: colour switching via a switch on the universal plug

Bicoloured LED beacons

switchable between blue and amber

MOVIA - SL



PRODUCT FEATURES:

- suitable for cars
- available as fix mounting or magnetic fixing
- fix mounting/CiA447: colour switching via signal line
- magnetic fixing: colour switching via a switch on the universal plug
- clear lamp dome
- protective cover optionally available

COMET LED



PRODUCT FEATURES:

- suitable for cars
- available as fix mounting or magnetic fixing
- fix mounting/CiA447: colour switching via signal line
- magnetic fixing: colour switching via a switch on the universal plug
- clear lamp dome

COMET (S) on support bracket

This mounting form of the COMET and COMET S beacons has been specially developed for escort vehicles. The beacon is fastened to the vehicle roof by means of a lockable plug-in hinge and a magnetic rubber suction cup. Universal electric plug-in hinge attachment parts (ESA part) provide both a secure hold and the voltage supply for the beacon.

COMET S PRODUCT FEATURES:

- suitable for cars
- various homologated flash patterns integrated
- two rows of LEDs
- class II homologation
- analogue
- height: 85 mm (plus support bracket)
- colours: also available in red and blue
- also available with clear lamp dome



Fig.: COMET S on support bracket with ESA part
Similar to illustration



Fig.:
COMET on support bracket
without ESA part

Similar to illustration

COMET PRODUCT FEATURES:

- suitable for cars
- three rows of LEDs
- class I homologation
- analogue
- height: 158 mm (plus support bracket)
- colours: also available in red and blue

SUPPORT BRACKET PRODUCT FEATURES:

- suitable for cars
- lockable clamping element
- self-contacting via multi-contact segments in the ESA part
- double protection with a plug-in hinge and magnetic suction cup
- universal ESA part required

With the HT solutions from Hänsch you can ensure the legally required geometric visibility even if the mounting of conventional beacons is not possible due to the structural conditions.

The HT solution, also referred to as a half beacon or half lightbar, can be mounted at the front or rear of the vehicle or integrated into the vehicle body.

The various solutions from Hänsch, consisting of 2 to 6 HT lamp bodies, allow you maximum flexibility in mounting on the vehicle body. With the Sputnik mini and Sputnik SL HT solutions, installation at the front of the vehicle ensures the earliest possible warning effect, e.g. at intersections or at exits.



**INTEGRO Universal
LED module**



Sputnik mini HTA



Sputnik SL HTA

Further information can be found on page 71.

Integro Universal LED module

For the safety of the vehicle, this flexibly usable LED module can be integrated in the roof structure at the front and rear. All four amber LED modules together create a beacon. One module, two mounting versions: the compact integrated solution provides for a high warning effect and safety in road traffic.



Homologation (Germany and international):

Light according to ECE-R 65:	HTA1 (E1) 00 3850
EMC according to ECE-R 10:	(E1) 10R-06 4465

The homologation is only valid if used in pairs at the front and/or rear of the vehicle.

PRODUCT FEATURES:

- one system consists of two identical lamp bodies
- 8 high-performance LEDs with wide angle optics
- integrated control electronics
- Voltage: 12 V / 24 V multi-voltage
- connection for function monitoring
- 270° beam angle
- synchronisation of several modules possible
- homologation as a half beacon
- colours: also available in blue and red

INTEGRATION OPTIONS:

- the LED modules can be fastened at the front and/or rear of the vehicle or integrated in the roof structure of the vehicle
- each pair of Integro LED modules (front or rear) can be replaced by a beacon or a roof lightbar system

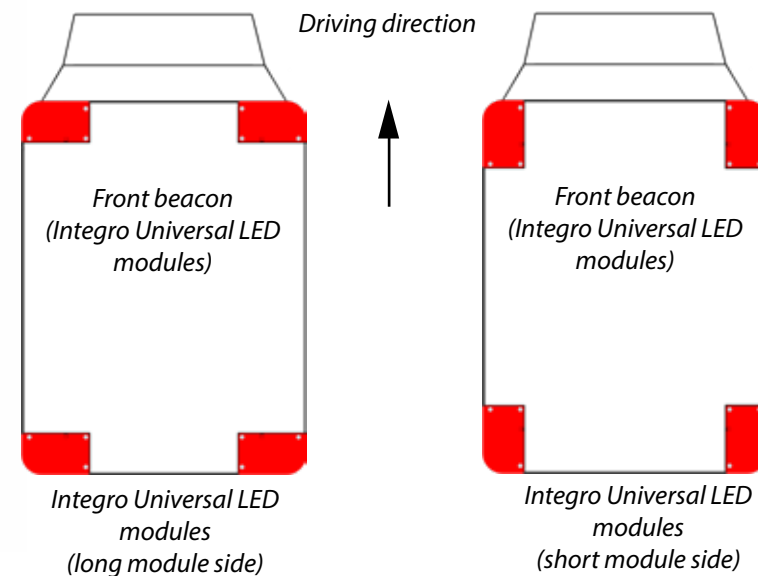

Sputnik mini HTA

The Sputnik mini LED warning system impresses with its compact dimensions and simple installation method in the round drill hole. An HT solution consists of 4 Sputnik mini lamp bodies and 2 Sputnik SL mini lamp bodies. The beacon as an HT solution consists of several visual systems, therefore it is not a directional beacon (front flasher).



Lamp body dimensions:
27 mm x 28 mm
(diameter x height)



PRODUCT FEATURES:

- very compact design for universal use
- housing: aluminium
- external electronics for 2 lamp bodies
- vehicle-specific HT solutions available: MB Sprinter, VW Crafter, MAN TGE, further volume models or projects on request

VERSION:

1. HT system consisting of 4 Sputnik SL HT mini lamp bodies and 2 Sputnik SL lamp bodies
(Y-cable available for easy electrical connection)

The use of HT systems is regulated differently in different countries. We recommend that you enquire to your local admissions office beforehand.

Sputnik mini HTA



Similar to illustration (photomontage)

Technical data:

Material	Housing:	aluminium, black anodised
	Cover glass:	PC
	Electronics:	PA
Dimensions:	Lamp body:	Ø 27 mm, depth 28 mm
	Electronics:	95.5 x 26 x 13 mm (W x H x D)
Weight:	Lamp body:	25 g
	Electronics:	245 g
Type of protection:	IP6K7 / IPX9K	
Temperature range:	-40 °C to +60 °C	
Avg. power consumption*:	0.8 A at 12 V	
	0.5 A at 24 V	
Peak*:	2.3 A at 12 V	
	1.1 A at 24 V	
*Electronics with 2 lamp bodies		
Flash pattern:	Synchronous strobe flash (configurable)	
Homologations: (Germany and international)		
Light acc. to ECE-R 65:	HTA1 (E5) 00 0072	
EMC acc. to ECE-R 10:	(E1) 10R-05 8617	

System consisting of:

- 2 lamp bodies Sputnik SL
- 4 lamp bodies Sputnik mini

- voltage: 12 V / 24 V multi-voltage
- flash pattern: synchronous, alternating
- option: activation control
- cable harness available for simplified electrical connection

Sputnik SL HTA

The lamp bodies of the Sputnik SL HTA solution feature state-of-the-art lighting technology. The cover glass and the integrated optics of the LEDs guarantee maximum light output and a large angle of radiation (horizontal > 70°). In particular at intersections, the wide beam angle increases other road users' awareness, thus reducing the risk of accidents.

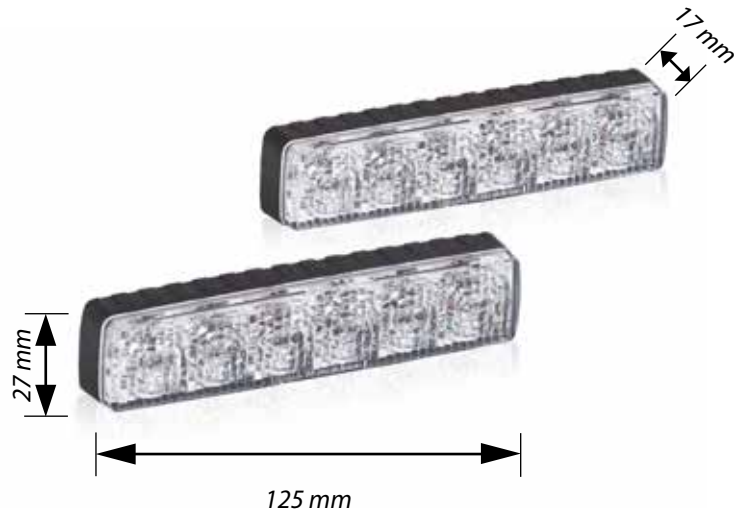

Similar to illustration (photomontage)

PRODUCT FEATURES:

- maximum warning effect > 500 candela
- can be adjusted to the contour of the radiator grille
- complete sealing of the lamp bodies ensures insensitivity to high pressure or steam jet cleaning
- universal holders and various vehicle-specific holders are available for optimal orientation and easy mounting at the front of the vehicle
- cable harness available for simplified electrical connection

System consisting of:

- 4 lamp bodies Sputnik SL

Technical data:	
Designation:	Sputnik SL
Voltage:	12 V / 24 V multi-voltage
Average power consumption:	12 V: 0.8 A (per lamp body) 24 V: 0.6 A (per lamp body)
Type of protection:	IP6K7 / IPX9K
Homologation:	
Light according to ECE-R 65:	HTA1 (E) 00 4125
EMC according to ECE-R 10:	(E) 10R-05 6845

Lightbar systems



Lightbar systems

- **Highest safety through perfection**

Today, Hänsch lightbar systems are an essential piece of equipment for highway depots, maintenance depots, local authority services and other municipal facilities. A maximum warning effect is achieved through the use of state-of-the-art lighting technology, thus increasing safety for all road users. All lightbar systems are available in different lengths and versions. They are modular and feature a wide range of functions.



DBW 850



divided DBW 850



DBW 5000



reddot award 2017
winner



DBW 4000



reddot design award
winner 2013

DBW 850

The DBW 850 product family includes not only the divided version, but also the full-length version. The latter also impresses with its new, state-of-the-art design with clear contours and the technical innovations.



Customisable

- fitted using a modular system
- flexibly adaptable to individual needs

Variety of mounting options

- fast and easy mounting options for flat or curved vehicle roofs
- special vehicle-specific carrier systems offer additional mounting options

Simple control concept

- control/operation – via CiA447, FireCAN or analogue

Variety of lengths

- lengths: 400 mm, 650 mm, 1100 mm, 1200 mm, 1400 mm, 1600 mm, 1800 mm



Height: 95 mm

Depth: 280 mm

Width: 400-1800 mm

PRODUCT FEATURES

- controller: CiA447, FireCAN and analogue
- 12 V /24 V multi-voltage
- automatic day/night switching
- main beacon consisting of 4 corner modules
- main beacon is multicolour-capable
- middle modules are multicolour-capable (up to two different colours per module)
- extension of the light functions with up to 12 middle modules
- use of the roof mounting systems of DBW 4000/5000
- EMC according to ECE-R 10

RANGE OF FUNCTIONS AVAILABLE*

- amber beacon class II (according to ECE-R 65)
- amber direction indicator (front/rear) (according to ECE-R 148)
- additional flashers
- lighting for the surrounding area (alley lights 20°)
- search light (alley lights 0°)
- working lights

*May be limited depending on control

Homologation:	
Light according to ECE-R 65:	TA2 E1 00 5278 DBS 850-A (amber)
light according to TA13a:	~ K 2089
EMC according to ECE-R 10:	(E1)10R-06 9655

DBW 850 divided

Emergency services have been relying on the design and reliability of the divided roof lightbar systems from Hänsch for over 20 years. The DBW 850 is a completely new development and is the successor to the DBW 975. Cover glasses and lamp domes have been given a modern appearance with clear contours, while the aluminium profile and mounted covers have deliberately been kept dark. To meet the highest demands for the light intensity, the rod paraboloid lens familiar from the DBW 5000 is used. The light modules behind it can have up to three colours and are designed to be multifunctional via the internal bus. The wiring and mounting options are compatible with the DBW 4000/DBW 5000 systems.



Customisable

- fitted using a modular system
- flexibly adaptable to individual needs

Variety of mounting options

- fast and easy mounting options for flat or curved vehicle roofs

Simple control concept

- control/operation – via CiA447, FireCAN or analogue

Variety of lengths

- lengths: 2 x 400 or 2 x 650 mm

DBW 850 divided



Height: 95 mm

Depth: 280 mm

Width: 400 or 650 mm

PRODUCT FEATURES

- controller: CiA447, FireCAN and analogue
- 12 V / 24 V multi-voltage
- automatic day/night switching
- main beacon is multicolour-capable
- middle modules are multicolour-capable (up to two different colours per module)
- extension of the light functions with middle modules
- use of the roof mounting systems of DBW 4000/5000
- EMC according to ECE-R 10

RANGE OF FUNCTIONS AVAILABLE*

- amber beacon class II (according to ECE-R 65)
- amber direction indicator (front/rear) (according to ECE-R 148)
- additional flashers
- lighting for the surrounding area (alley lights 20°)
- search light (alley lights 0°)
- working lights

*May be limited depending on control

DBW 5000

The DBW 5000 warning system combines modern design, a versatile range of functions and powerful LED lighting technology. The optimum warning effect increases road users' awareness and ensures additional safety when in operation in road traffic. The minimal installation height not only ensures low drag and a reduced noise level, but also makes it possible to pass under structures with low clearance heights.



**reddot award 2017
winner**

Customisable

- fitted using a modular system
- flexibly adaptable to individual needs
- multi-colour middle modules

Aerodynamic housing

- low wind resistance and reduced noise level
- low-profile design

Variety of mounting options

- fast and easy mounting options for flat or curved vehicle roofs
- special vehicle-specific brackets offer additional mounting options

Maximum warning effect

- state-of-the-art lighting technology
- automatic day/night switching

Simple control concept

- digital control via the CANBus protocol, based on the CANopen standard 447
- converters for analogue control available

Variety of lengths

- lengths: 700, 1100, 1200, 1400, 1600 or 1800 mm



RANGE OF FUNCTIONS AVAILABLE

- working lights
- automatic day/night switching
- lighting for the surrounding area (alley lights 20°)
- search light (alley lights 0°)
- undercarriage loudspeaker for public address
- additional flashers
- direction indicator*
- traffic advisor (special approval required)
- also available with clear lamp dome

*with CiA447, an I/O box for reading the analogue signals is required.

Also available in a version conforming to ICAO type C.
Further information can be found on page 62.

Technical data:	
Designation:	DBW 5000
Voltage:	12 V / 24 V
Flash frequency:	> 2 Hz (beacon)
Average power consumption:	from 4 A (at 12 V)
Lengths:	700, 1100, 1200, 1400, 1600, 1800 mm
Depth:	285 mm
Height:	63 mm
Weight:	from 5.1 kg
Material:	lamp dome: PC / cover glass: PMMA housing: aluminium
Type of protection:	IP5K4K / IPX9K
Homologation: (Germany and international)	
Light according to ECE-R 65:	TA2 (E1) 00 4448 / TA2 (E1) 00 4447
EMC according to ECE-R 10:	(E1) 10R-05 7981
Direction indicator: light according to ECE-R 6	01 1 (E1) 4453 (front) / 01 2a (E1) 4453 (rear)

DBW 5000

Lamp dome

- amber
- clear
- red

Cover profile

Main beacon with function monitoring, optional:

- direction indicator

Alley lights

- lighting for the surrounding area (20°) or search light (0°)

Cover glass

- white
- amber
- clear
- amber transparent

LED modules (middle section)

- working lights
- additional flashers

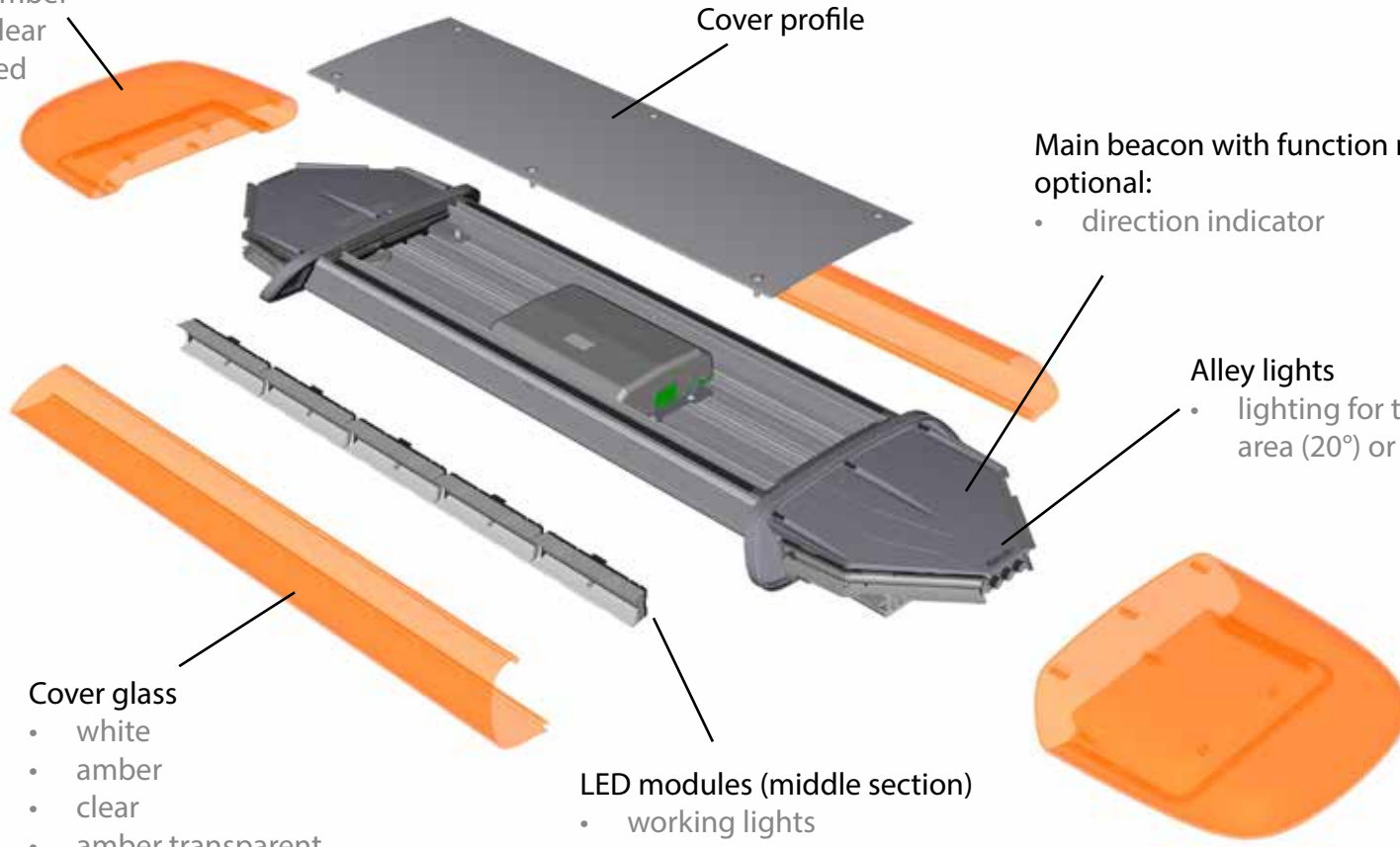



Basic lightbar

Possible lengths
700, 1100, 1200, 1400, 1600, 1800 mm

Main beacon (HKL)	
Function	
Main beacon (amber)	<ul style="list-style-type: none"> high-performance LEDs with wide angle optics class 2 homologation with automatic day/night switching integrated function monitoring flash pattern: strobe flash optional: direction indicator, front and/or rear, in the main beacons*

Control module (KM)	
Function	
Digital control	<ul style="list-style-type: none"> serial control via 2-wire cable for CiA447 control units (e.g. BE 300, HBE 300, BE 304) compatibility with other control units on request
Analogue control	<ul style="list-style-type: none"> converters for analogue control available analogue control via signal cable for limited range of functions (compatibility on request)

Roof mounting		
Function		
	Rubber mouldings	<ul style="list-style-type: none"> for flat or curved vehicle roofs
	Mounting brackets	<ul style="list-style-type: none"> universal and various vehicle-specific versions available



*with CiA447, an I/O box for reading the analogue signals is required.

DBW 5000

Electrical connection	
Function	
Cable outlet	<ul style="list-style-type: none"> • cable outlet on passenger side: standard • cable outlet on driver side • separate cable outlet (power supply and signal cables are laid separately) • vehicle-specific electrical connections on request

Options

Acoustic (undercarriage loudspeaker for public address)		
Function		possible with
Undercarriage loudspeakers	<ul style="list-style-type: none"> • undercarriage loudspeakers directed towards the rear and/or front for public address • external amplifier and cable harness required 	<ul style="list-style-type: none"> • 12 V • 24 V

Alley lights (side lights)*			
Function			possible with
	Lighting for surrounding area	<ul style="list-style-type: none"> • tilt angle: 20 ° • mounted in pairs (left and right) 	<ul style="list-style-type: none"> • 12 V • 24 V
	Search lights	<ul style="list-style-type: none"> • without tilt angle • mounted in pairs (left and right) 	<ul style="list-style-type: none"> • 12 V • 24 V

*We recommend a clear lamp dome for white radiation.

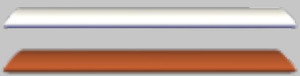
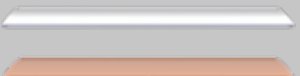
Cover glass		
Description		
	Cover glass in full colour: <ul style="list-style-type: none"> • white (RAL 9010) • amber (RAL 2004) 	
	Cover glass, transparent: <ul style="list-style-type: none"> • clear • amber transparent 	<ul style="list-style-type: none"> • clear or tinted transparent cover glass • required when mounting middle modules

Middle modules

Options – front mounting

Configuration example



Product	Product / colour	Product / colour
HKL	ZB / amber	ZB / amber
	ASW / white	ASW / white
	● ○	● ○

Product / colour	Product / colour	Product
ZB / amber	ZB / amber	HKL
ASW / white	ASW / white	
● ○	● ○	

HKL: main beacon
 ZB: additional flashers
 ASW: working lights

Additional flashers (ZB) and working lights (ASW)*	
Function	
Additional flashers (pair)* max. 3 pairs, depending on the length	<ul style="list-style-type: none"> • amber LEDs in reflector housing • directional • synchronisation with respective main flasher • reduced in night mode
Working light (0°) max. 4 per bar	<ul style="list-style-type: none"> • white LEDs in reflector housing • selectable mounting position • 1500 lumens
*2, 4 or 6 modules permissible	



Driving direction

Overview of the module slots

Example configuration 1200 mm:

Module 2+10 = additional flasher

Module 4+8 = working light

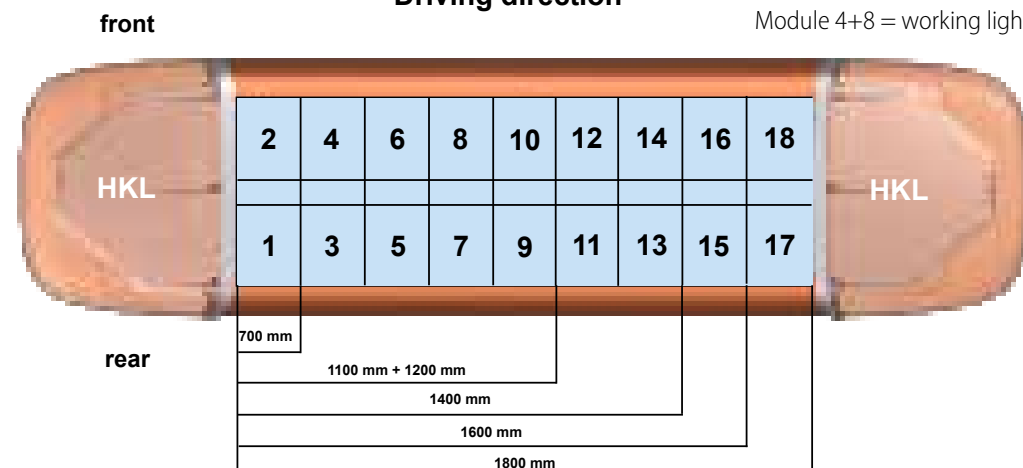

DBS 5000

switchable between blue and amber

The DBS 5000 bicolour lightbar system is switchable between blue and amber.

The blue warning signal is used to indicate the right of way when travelling to the destination.

The beacon can be switched to amber at the destination in order to act as a warning signal to secure the area.



PRODUCT FEATURES:

- switchable between blue and amber
- both colours are homologated according to ECE-R 65

RANGE OF FUNCTIONS AVAILABLE

- blue: can be used to indicate the right of way while driving
- amber: can be used as a warning signal at the destination
- blue additional flashers
- amber additional flashers
- direction indicator*
- working lights
- lighting for the surrounding area (alley lights 20°)
- search light (alley lights 0°)
- rear warning system (amber)
- power flash (blue)
- automatic day/night switching

*with CiA447, an I/O box for reading the analogue signals is required.

Also available in a version conforming to ICAO type C.
Further information can be found on page 62.

Technical data:

Designation:	DBS 5000
Voltage:	12 V / 24 V
Flash frequency:	> 2 Hz (beacon)
Average power consumption:	from 4 A (at 12 V)
Lengths:	700, 1100, 1200, 1400, 1600, 1800 mm
Depth:	285 mm
Height:	63 mm
Weight:	from 5.1 kg
Material:	lamp dome: PC / cover glass: PMMA housing: aluminium
Type of protection:	IP5K4K / IPX9K
Homologation: (Germany and international)	
Light according to ECE-R 65:	TB2 (E1) 00 4446 / TA2 (E1) 00 4447
EMC according to ECE-R 10:	(E1) 10R-05 7981
Direction indicator: Light acc. to ECE-R 6:	01 1 (E1) 4453 (front) / 01 2a (E1) 4453 (rear)
Rear warning system**: Light acc. to ECE-R 65:	XA1 (E1) 00 4471
Power flash***: light according to TA 13a:	~ K 1427

**Only permissible with blue lightbars in accordance with Art. 52 Para. 11 of the German Road Traffic Licensing Regulations.

***Only permissible with blue lightbars.

Hänsch®

DBW 4000

The DBW 4000 warning system combines modern design, a versatile range of functions and powerful LED lighting technology. The optimum warning effect increases road users' awareness and ensures additional safety when in operation in road traffic. Thanks to numerous selectable functions, the DBW 4000 can be adapted individually to every area of application.



Customisable

- fitted using a modular system
- flexibly adaptable to individual needs

Aerodynamic housing

- low wind resistance and reduced noise level

Variety of mounting options

- fast and easy mounting options for flat or curved vehicle roofs
- special vehicle-specific carrier systems offer additional mounting options

Maximum warning effect

- state-of-the-art lighting technology
- automatic day/night switching

Simple control concept

- analogue or digital control via the CANBus protocol, based on the CANopen standard 447 or fireCAN

Variety of lengths

- lengths: 1100, 1200, 1400, 1600, 1800 or 2000 mm

DBW 4000



RANGE OF FUNCTIONS AVAILABLE

- traffic advisor
- direction indicator*
- working lights
- additional flashers
- lighting for the surrounding area (alley lights 20°)
- search light (alley lights 0°)
- undercarriage loudspeaker for public address
- full matrix display (special approval according to Art. 70 required)
- rear warning system
- cover glass printing
- automatic day/night switching

*with CiA447, an I/O box for reading the analogue signals is required.

Also available in a CiA447 version conforming to ICAO type C.
Further information can be found on page 62.

<i>Technical data:</i>	
Designation:	DBW 4000
Voltage:	12 V / 24 V
Flash frequency:	> 2 Hz (beacon)
Average power consumption:	from 4 A (at 12 V)
Lengths:	1100, 1200, 1400, 1600, 1800, 2000 mm
Depth:	300 mm
Height:	140 mm
Weight:	from 9.0 kg
Material:	lamp dome: PC / cover glass: PMMA housing: aluminium
Type of protection:	IP5K4K / IPX9K
<i>Homologation: (Germany and international)</i>	
Light according to ECE-R 65:	TA2 (E1) 00 3111
EMC according to ECE-R 10:	(E1) 10R-05 6209
Direction indicator: light according to ECE-R 6	01 1 (E1) 3822 (front) / 01 2a (E1) 3800 (rear)
RWS: light according to TA 20:	wwwK 810

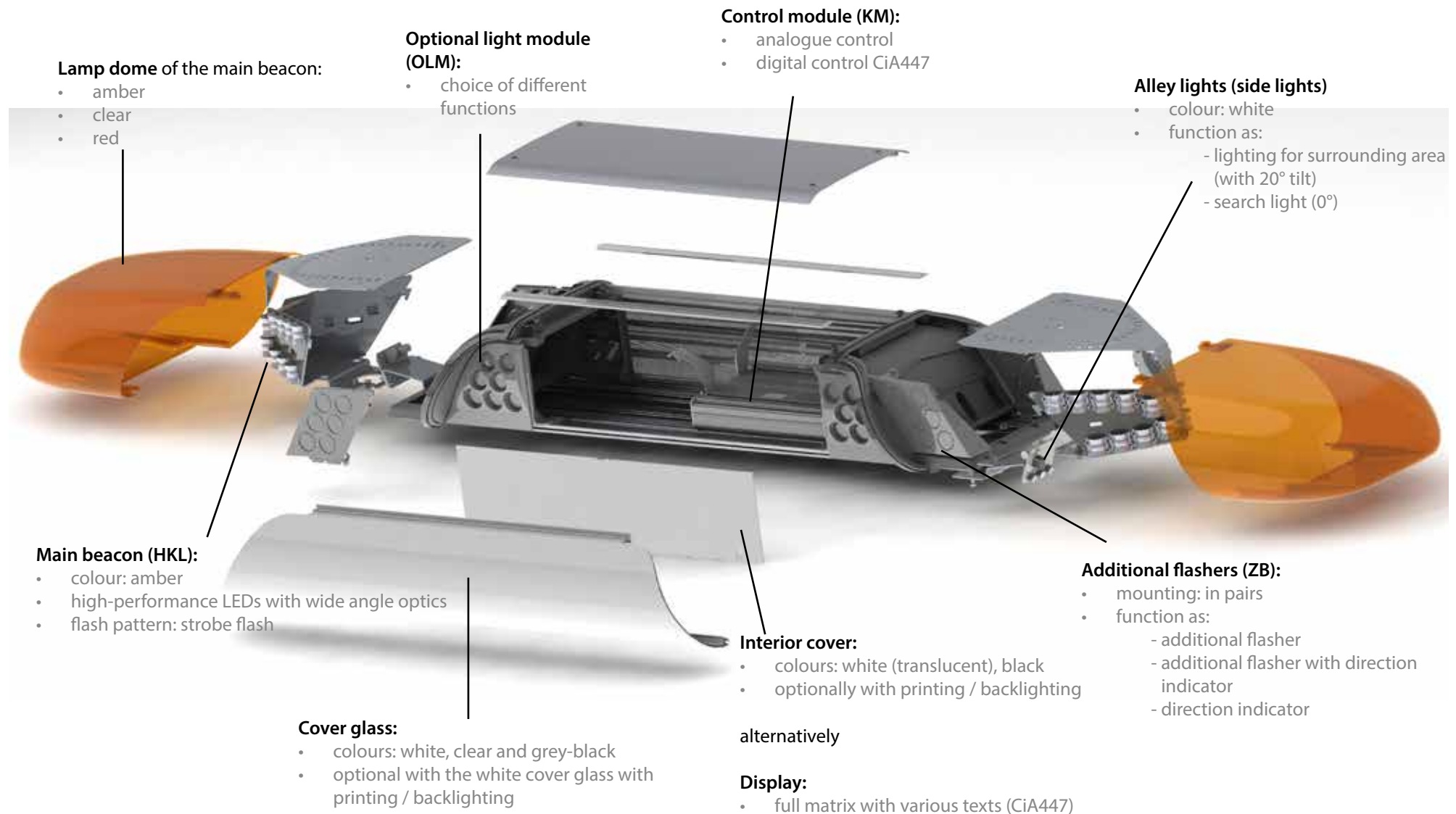

DBW 4000

Basic lightbar

Possible lengths

1100, 1200, 1400, 1600, 1800 and 2000 mm

Main beacon (HKL)

Function

Main beacon (amber)	<ul style="list-style-type: none">• high-performance LEDs with wide angle optics• class 2 homologation with automatic day/night switching• integrated function monitoring• flash pattern: strobe flash
---------------------	---

Control module (KM)

Function

Analogue control	<ul style="list-style-type: none">• for single switch and various common analogue control units (e.g. BE200 or BE600)
Digital control	<ul style="list-style-type: none">• serial control via 2-core cable• for CiA447 control units (e.g. BE 300, HBE 300, BE 304)• compatibility with other control units on request

Roof mounting

Rubber mouldings	<ul style="list-style-type: none">• for flat or curved vehicle roofs
Mounting brackets	<ul style="list-style-type: none">• universal and various vehicle-specific versions available
Flat seal	<ul style="list-style-type: none">• for flat vehicle roofs



Electrical connection

Function

Cable outlet	<ul style="list-style-type: none">• cable outlet on passenger side: standard• cable outlet on driver side• separate cable outlet (supply and signal cables are laid separately)
--------------	---

Options

Acoustic		
Function		possible with
Undercarriage loudspeaker (UKL)	<ul style="list-style-type: none"> undercarriage loudspeaker directed towards the front/rear for the support of public address with integrated or external amplifier (combination with TFA 624 only in CiA447) 	<ul style="list-style-type: none"> 12 V 24 V

Alley lights (side lights)		
Function		possible with
	Lighting for surrounding area <ul style="list-style-type: none"> colour: white tilt angle: 20 ° mounted in pairs (left and right) 	<ul style="list-style-type: none"> 12 V 24 V
	Search lights <ul style="list-style-type: none"> colour: white without tilt angle mounted in pairs (left and right) 	<ul style="list-style-type: none"> 12 V 24 V

*We recommend a clear lamp dome for white radiation.

Display and printing	
Function	
Cover glass (colours: white, clear and grey)	<ul style="list-style-type: none"> standard: white without printing optional: white with printing (backlighting possible) optional: clear without printing (interior cover or display required); the clear cover glass is mandatory when OLMs are used
Interior cover (colours: white and black)	<ul style="list-style-type: none"> standard: white without printing optional: white with printing optional: black without printing optional: black with printing
Display	<ul style="list-style-type: none"> various texts possible with digital control module

DBW 4000

Options – front mounting

Configuration example

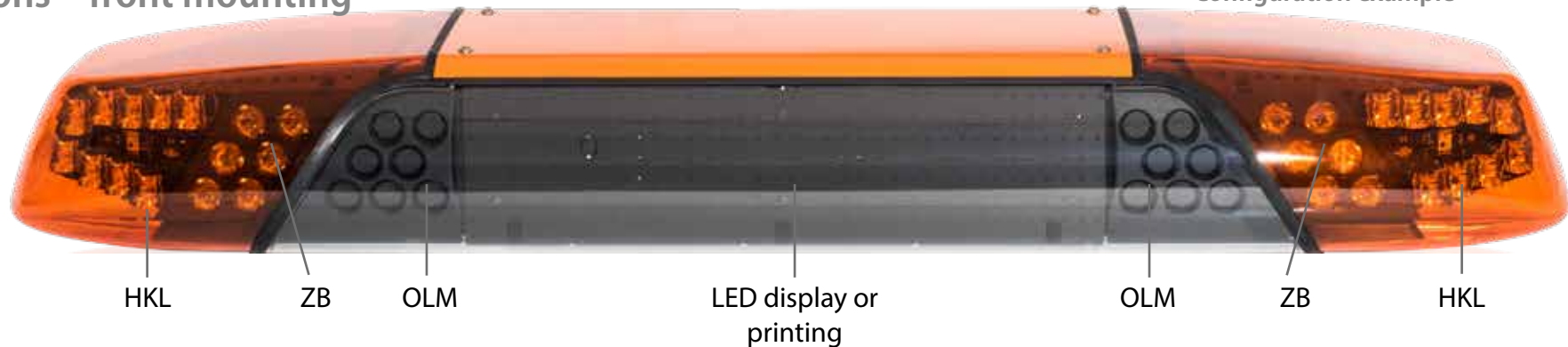

additional flashers			
Function			possible with
ZB	Additional flashers (pair)	<ul style="list-style-type: none"> consisting of 12 amber LEDs directional synchronisation with respective main flasher deactivated in night mode 	<ul style="list-style-type: none"> 12 V 24 V
ZB	Additional flashers with direction indicator (pair)*	<ul style="list-style-type: none"> consisting of 6 amber LEDs (additional flashers) and 8 amber LEDs (direction indicators) directional additional flasher: deactivated in night mode; synchronisation with respective main flasher direction indicator: function as direction indicators or hazard warning lights (synchronisation with vehicle direction indicator necessary) 	<ul style="list-style-type: none"> 12 V
ZB	Direction indicators (pair)*	<ul style="list-style-type: none"> consisting of 8 amber LEDs directional function as direction indicators or hazard warning lights (synchronisation with vehicle direction indicator necessary) 	<ul style="list-style-type: none"> 12 V
Optional light module (OLM)			
Function			possible with
OLM	Working light (ASW)	<ul style="list-style-type: none"> consisting of up to 9 white LEDs per module standard: mounted on the right-hand side (passenger side) an additional unit can be mounted on the left-hand side (driver side) as an option light intensity: <ul style="list-style-type: none"> - 600 lumens - 1000 lumens - 1500 lumens (each with a 15° or 0° tilt angle) 	<ul style="list-style-type: none"> 12 V 24 V 12 V

*with CiA447, an I/O box for reading the analogue signals is required.

Options - rear mounting

Configuration example

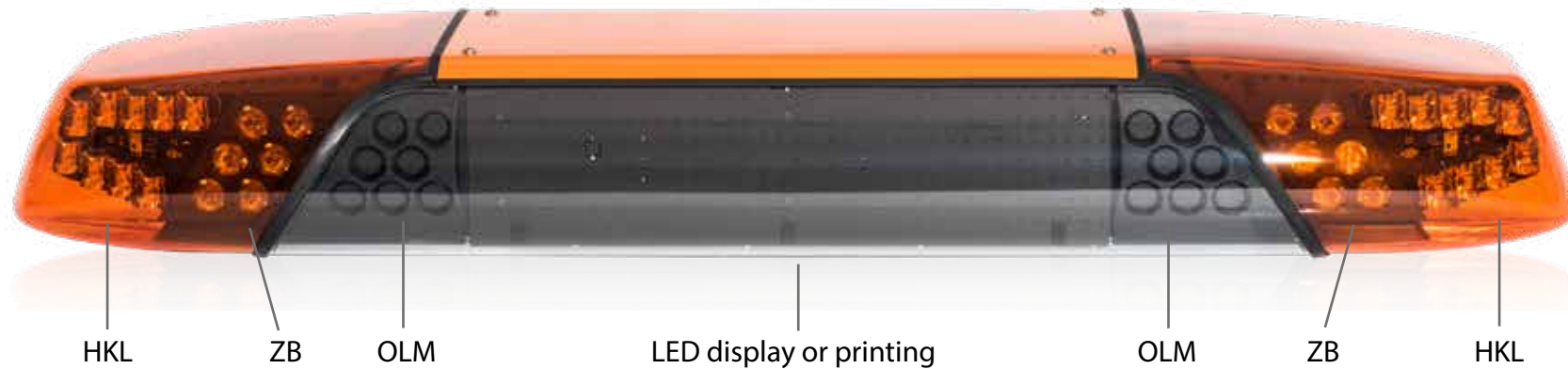

additional flashers			
Function			possible with
ZB	Additional flashers (pair)	<ul style="list-style-type: none"> consisting of 8 amber LEDs directional synchronisation with respective main flasher deactivated in night mode 	<ul style="list-style-type: none"> 12 V 24 V
ZB	Additional flashers with direction indicator (pair)*	<ul style="list-style-type: none"> consisting of 6 amber LEDs (additional flashers) and 8 amber LEDs (direction indicators) directional additional flasher: deactivated in night mode; synchronisation with respective main flasher direction indicator: function as direction indicators or hazard warning lights (synchronisation with vehicle direction indicator necessary) 	<ul style="list-style-type: none"> 12 V
ZB	Direction indicators (pair)*	<ul style="list-style-type: none"> consisting of 8 amber LEDs directional function as direction indicators or hazard warning lights (synchronisation with vehicle direction indicator necessary) 	<ul style="list-style-type: none"> 12 V

*with CiA447, an I/O box for reading the analogue signals is required.

DBW 4000

Options - rear mounting

Optional light module (OLM)			
Function		possible with	
OLM	Working light (ASW)*	<ul style="list-style-type: none"> consisting of up to 9 white LEDs per module standard: mounted on the right-hand side (passenger side) an additional unit can be mounted on the left-hand side (driver side) as an option light intensity: <ul style="list-style-type: none"> - 600 lumens - 1000 lumens - 1500 lumens (each with a 15° or 0° tilt angle) 	<ul style="list-style-type: none"> 12 V 24 V 12 V
OLM	Rear warning system (RWS)	<ul style="list-style-type: none"> consisting of 6 amber LEDs per module available exclusively in pairs (mounted left and right) 	<ul style="list-style-type: none"> 12 V 24 V

* A combination of the two OLM options is not possible. If required, the working lights can only be combined with the LED rear warning system type 40 pico LED.

RWS type 40 pico LED		
Function		possible with
RWS 40 pico LED*	<ul style="list-style-type: none"> one lamp body consists of 8 LEDs lamp body: <ul style="list-style-type: none"> - 1100 mm: 2 lamp bodies - 1200 mm: 2 lamp bodies - 1400 mm: 3 lamp bodies - 1600 mm: 4 lamp bodies - 1800 mm: 5 lamp bodies - 2000 mm: 5 lamp bodies rear-facing lights can also be integrated as OLMs 	<ul style="list-style-type: none"> 12 V 24 V

* not combinable with OLM RWS

Special functions		
Traffic advisor*	<ul style="list-style-type: none"> consists of 6 amber LED modules, each with 3 LEDs for rear mounting choice of different flash patterns (warning function, RWS function) or traffic advisor function (arrow stick function)) 	
Convoy	<ul style="list-style-type: none"> "convoy front" switches the rear part of the main beacon (HKL) and the rear additional flasher (ZB) off in order not to blind the following traffic "convoy rear" switches the front part of the main beacon (HKL) and the front additional flasher (ZB) off in order not to blind the traffic travelling ahead 	

* no homologation as RWS. Special approval required for traffic advisor.

DBS 4000

switchable between blue and amber

The DBS 4000 bicolour lightbar system is switchable between blue and amber.

The blue warning signal is used to indicate the right of way when travelling to the destination.

The beacon can be switched to amber at the destination in order to act as a warning signal to secure the area.



PRODUCT FEATURES:

- switchable between blue and amber
- both colours are homologated according to ECE-R 65
- blue: can be used to indicate the right of way while driving
- amber: can be used as a warning signal at the destination
- optional: integration of additional flashers to reinforce the respective warning effect
- blue additional flashers facing forwards and/or rearwards possible
- amber additional flashers facing forwards and/or rearwards possible
- installation of undercarriage loudspeakers possible

Also available in a CiA447 version conforming to ICAO type C.
Further information can be found on page 62.

Technical data:	
Designation:	DBS 4000
Voltage:	12 V / 24 V
Flash frequency:	> 2 Hz (beacon)
Average power consumption:	from 4 A (at 12 V)
Lengths:	1100, 1200, 1400, 1600, 1800, 2000 mm
Depth:	300 mm
Height:	140 mm
Weight:	from 9 kg
Material:	lamp dome: PC / cover glass: PMMA housing: aluminium
Type of protection:	IP5K4K / IPX9K
Homologation: (Germany and international)	
Light according to ECE-R 65:	TB2 (E1) 00 3111 / TA2 (E1) 00 3111
EMC according to ECE-R 10:	(E1) 10R - 05 6209

Control units

The various functions of the control units in the vehicles must be as fast, reliable and easy to operate as possible. The most important functions can be accessed using the fast access buttons. Whether built-in or hand-held control unit, we offer a wide range of versions for the most diverse areas of application.



HBE 300 hand-held control unit



BE 304 control unit



BE 200/300 control units

Both CAN-capable warning systems and analogue supplements can be controlled with the HBE 300. A special version of the HBE 300 has been developed for the amber area.



PRODUCT FEATURES:

- CANopen standard 447
- 8 fast access buttons
- 4 menu buttons
- buttons with location and activation lighting
- integrated microphone for public address option
- high-contrast wide-angle display
- easy to operate thanks to large buttons
- convenient menu with self-explanatory icons
- analogue outputs for additional functions
- usable in any vehicle (even without a 447 gateway)
- various models available
- ideal for controlling DBW 4000, DBW 5000 and DBW 850









Homologation: (Germany and international)

EMC according to ECE-R 10:

Ⓔ 10R-05 6932





HBE 300

Examples:

Functions of the fast access buttons (HBE300 GE1)	
	Switches on the main beacons and, if applicable, the front flashers and 3rd beacon together. The night-time reduction is activated during operation by pressing and holding the button (>3 sec.).
	Switches the front flasher on/off when the main beacons are activated. (interlocked with the main beacons)
	Switches the working lights installed at the front on/off. A condition (release signal) may be required or configurable.
	Switches the working lights installed at the rear on/off. A condition (release signal) may be required or configurable.
	Switches the backlighting of the lettering in the bar on/off. A quiet tone sequence cycle is triggered by pressing and holding the button when the main beacons are activated and the ignition is switched on (terminal 15).
	Switches the rear warning system on/off. A condition (release signal) may be required or configurable.
	Switches the working lights installed at the left on/off. A condition (release signal) may be required or configurable.
	Switches the working lights installed at the right on/off. A condition (release signal) may be required or configurable.

Technical data (without holder tray)	
Weight:	170 g
Dimensions:	66 x 124 x 24 mm (W x H x D)
Voltage:	12 V / 24 V multi-voltage



Functions of the menu navigation buttons (HBE300)	
	Navigate upwards through menu items and functions.
	Navigate downwards through menu items and functions.
	Select and choose menu items and function.
	Return to the previous menu item level. You can also switch off all active functions by pressing and holding this button.

The BE 304 control unit impresses with a compact housing and various mounting options. The raised buttons with a clear pressure point provide a very good feel. This control unit is ideally suited for undercover police operations as well as for other emergency and work vehicles with a basic set of functions. Due to its versatile range of functions, the BE304 can be optimally configured for any area of application.



PRODUCT FEATURES:

- compact plastic housing
- 4 function buttons for controlling CAN-capable products
- location and activation lighting
- can be positioned horizontally or vertically (4x1 or 1x4)
- Combination of several control units or as an additional keypad for other CAN control units (Individual consideration required, please contact our Sales dept.)
- 4-core connection cable via cable harness to CAN components
- 12 V / 24 V
- surface mounted version; built-in version on request
- including analogue inputs and outputs

AREAS OF APPLICATION:

- amber area: building site vehicles, maintenance depots, builder's yards, general commercial vehicles, airports
- vehicles with a reduced range of warning functions
- undercover police operation
- simple fire brigade vehicles
- replacement for single switches in CAN systems

Homologation: (Germany and international)	
EMC according to ECE-R 10:	E110R-05 8548
Technical data	
Weight:	45 g
Dimensions:	84 x 26 x 15.5 mm (W x H x D)

BE 300 control units (digital)

BE 308 GE Universal 1



The BE 308 GE control unit has both a serial interface meeting the CiA447 standard and additional analogue outputs for controlling non-CAN-enabled equipment. A total of 8 buttons are used to operate the warning system functions safely.

PRODUCT FEATURES:

- 8 function buttons for controlling CAN-capable products
- including analogue inputs and outputs (4 inputs and 10 outputs)
- small housing dimensions
- usable with or without vehicle gateway
- various button assignments available
- cover for DIN car radio slot available
- ideal for controlling DBW 4000 and DBW 5000

Homologation: (Germany and international) HBE 300 control units

EMC according to ECE-R 10:

(E1) 10R-04 6703

BE 300M



PRODUCT FEATURES:

- purely menu-guided control unit
- exclusively for controlling a CiA447 full matrix
- selection of various texts for the full matrix
- cover for DIN car radio slot optionally available

Technical data (BE 308 & BE 300M)

Weight:	140 g
Dimensions:	93 x 52 x 24 mm (W x H x D)

INTEGRO – integrated solutions

- **Hänsch – the custom solutions specialist**

Hänsch has made a name for itself in Germany and abroad with its special solutions for visual and acoustic warning systems. Everything from a single source – from the development idea to the design and testing stages to the final homologation. The engineers from the Hänsch development centre are responsible for the entire project and support our customers in all questions and concerns.

We respond to our customers' individual requirements and develop high-quality tailor-made solutions! Many years of experience in the development of integrated solutions ensure the creation of a tailor-made vehicle concept, which is given its own identity through its modern design while also complying with European directives.



INTEGRO – integrated solutions

INTEGRO – our services – your benefits

- from the idea to the homologation
- customised solutions
- modern design

Along with standard products, our customers also receive special, integrated solutions perfectly adapted to their requirements (INTEGRO). This might include installing a beacon in the roof of a special-purpose vehicle according to the customer's ideas – the roof becomes the beacon and the vehicle's appealing design gives it its own identity and makes it highly recognisable.

For these projects, the Hänsch engineers work closely with vehicle manufacturers and special roof manufacturers to develop a concept, create a design and subsequently turn these ideas into reality. The final result is a vehicle that conforms to European directives.

OUR SERVICES:

- support from the idea to the homologation
- consulting during the construction phase*:
 - positioning, mounting, processing
- consulting during the design phase*:
 - the customer's identity must be unique
- handling of the homologation
- delivery of the adapted lighting technology:
 - highest light intensity with certificate

** If required, we will be happy to advise you. In addition, designers and engineers from Hänsch are at your disposal.*

BENEFITS:

Extensive experience with INTEGRO projects worldwide means:

- short implementation times
- expert advice
- certainty with regard to homologation
- flexible mounting options
- fully or partially integrated solutions to suit any budget
- homologation according to ECE-R 65, approval marks with E1 from the KBA
- fast turnaround times for requested changes or additions thanks to our in-house photometric and EMC labs



Rear warning systems

The Hänsch rear warning systems are the reliable add-ons to standard hazard warning systems. A system consists of at least two lamp bodies. It ensures a prompt warning of dangers in all weather and visibility conditions for vehicles following behind. All Hänsch rear warning systems are equipped with powerful LED technology.



**RWS
Sputnik
Compact**



**RWS
40 pico LED**



**RWS
Sputnik pico
LED**



**RWS
Sputnik SL**

Rear warning systems



Rack mounting (EG)



Surface mounting (AG)

RWS Sputnik Compact:

- 4 high-performance LEDs per lamp body
- special lens for optimised light distribution
- maximum warning effect
- electronics completely integrated in the lamp body
- available in built-in or surface-mounted versions
- easy mounting due to the compact and flat design
- long service life due to high-quality LED technology



Rack mounting (EG)



Surface mounting (AG)

RWS 40 pico LED:

- 8 high-performance LEDs per lamp body
- electronics completely integrated in the lamp body
- special lens for optimum light distribution
- available with or without mounting frame



Rack mounting (EG)



Surface mounting (AG)

RWS Sputnik pico LED:

- 4 high-performance LEDs per lamp body
- electronics completely integrated in the lamp body
- special lens for optimum light distribution
- available with or without mounting frame

Rear warning systems



RWS Sputnik SL:

- 6 high-performance LEDs per lamp body
- electronics completely integrated in the lamp body
- special lens for optimum light distribution
- maximum warning effect > 500 candela

Technical data:				
Designation:	RWS Sputnik Compact	RWS 40 pico LED	RWS Sputnik pico LED	RWS Sputnik SL
Voltage:	12 V / 24 V multi-voltage	12 V / 24 V	12 V / 24 V	12 V / 24 V multi-voltage
Flash frequency:	>2 Hz	>2 Hz	>2 Hz	>2 Hz
Average power consumption:	12 V: 0.25 A (per lamp body) 24 V: 0.14 A (per lamp body)	12 V: 2.5 A 24 V: 1.25 A	12 V: 1.5 A 24 V: 0.75 A	12 V: 0.4 A (per lamp body) 24 V: 0.2 A (per lamp body)
Dimensions (W x H x D):	EG: 73 x 34 x 2.5 mm AG: 90 x 31 x 10 mm	169.5 x 85 x 61 mm	80 x 80 x 60 mm	125 x 27 x 17 mm
Material:	Zn/ PC	ASA/ PC	ASA/ PC	Al/ PC
Type of protection:	IP6K5	IP5K4K	IP5K4K	IP6K7/ IPX9K
Homologation: (Germany)				
Light according to TA20:	D: ~ K 1160	D: ~ K 538	D: ~ K 544	D: ~ K 960 (hor.) / ~ K 1010 (vert.)
EMC according to ECE-R 10 or 72/245/EEC:	(E1)10R-04 7591	(E1)10R-06 4465	(e1)03 5635	(E1)10R-05 6845

Sputnik Hybrid

With its slim design, the new, narrow Hybrid front flasher from the Sputnik product family enables installation in cramped installation situations. Moreover the directional beacon has a high warning effect at intersections due to its special form.



PRODUCT FEATURES:

- 9 high-performance LEDs per lamp body
- electronics completely integrated in the lamp body
- integrated intersection warner
- for use on your own premises
- only permissible on vehicles with blue light in accordance with Art. 52 Para. 11 of the German Road Traffic Licensing Regulations (HWS)
- no homologation as additional warning lights in accordance with Art. 53a Para. 3 of the German Road Traffic Licensing Regulations (RWS)

Technical data:	
Designation:	Sputnik Hybrid
Voltage:	12 V: 0.7 A (per lamp body) 24 V: 0.3 A (per lamp body)
Homologation:	
Our amber Sputnik Hybrid directional beacons are homologated as a rear warning system according to Article 52 section 11 of the German Road Traffic Licensing Regulations.	
	XA2(E)00 5256 XA1(E)00 5257 XA2(E)00 5273 XA2(E)00 5274

A new dimension, despite the flat design!

Our Sputnik Flat impresses with its extremely flat design and optimal light yield. In addition, it offers a wide range of installation options on the vehicle, especially at the rear.



PRODUCT FEATURES:

- 6 high-performance LEDs per lamp body
- electronics completely integrated in the lamp body
- very flat design
- flexible installation options

- for use on your own premises
- only permissible on vehicles with blue light in accordance with Art. 52 Para. 11 of the German Road Traffic Licensing Regulations (HWS)
- no homologation as additional warning lights in accordance with Art. 53a Para. 3 of the German Road Traffic Licensing Regulations (RWS)

Technical data:	
Designation:	Sputnik Flat
Voltage:	12 V: 0.6 A (per lamp body) 24 V: 0.3 A (per lamp body)
Homologation:	
Our amber Sputnik Flat directional beacons are homologated as a rear warning system according to Article 52 section 11 of the German Road Traffic Licensing Regulations.	
	XA2(E)00 5261 XA1(E)00 5262 XA2(E)00 5264 XA2(E)00 5265

Sputnik mini

The new Sputnik mini LED warning system impresses with its compact dimensions and simple installation method in the round drill hole.



Lamp body dimensions:
27 mm x 27 mm x 30 mm
(diameter x height x depth)

PRODUCT FEATURES:

- very compact design for universal use
 - housing: aluminium
 - external electronics for 2 lamp bodies
 - X-homologation
 - also available in blue and red
-
- for use on your own premises
 - only permissible on vehicles with blue light in accordance with Art. 52 Para. 11 of the German Road Traffic Licensing Regulations (HWS)
 - no homologation as additional warning lights in accordance with Art. 53a Para. 3 of the German Road Traffic Licensing Regulations (RWS)

Technical data:		
Material	Housing:	aluminium, black anodised
	Cover glass:	PC
	Electronics:	PA
Dimensions:	Lamp body:	Ø 27 mm / depth 29.5 mm
	Electronics:	95.5 x 26 x 13 mm (W x H x D)
Weight:	Lamp body:	25 g
	Electronics:	245 g
Type of protection:	IP6K7 / IPX9K	
Voltage:	12 V / 24 V multi-voltage	
Temperature range:	-40 °C to +60 °C	
Avg. power consumption*:	0.8 A at 12 V	
	0.5 A at 24 V	
Peak*:	2.3 A at 12 V	
	1.1 A at 24 V	
*electronics with 2 lamp bodies		
Flash pattern:	Synchronous strobe flash (configurable)	
Homologations: (Germany and international)		
Light acc. to ECE-R 65:	XA1(E) 00 0071	
EMC acc. to ECE-R 10:	(E) 10R-05 8617	

Mobile warning and communication system

MOWACOM®

The mobile warning and communication system (MOWACOM) has been specially developed for professional users. It is designed in such a way that it can easily be transported, set up and operated by one person. The system is powered by the cigarette lighter, so it can be used without a mains power supply and also in private vehicles. The components, which have proven themselves in special applications, are integrated in the stackable protective case. The basic version includes a roof unit, a handset with integrated microphone for voice announcements and an amplifier with jack plug interface. It also includes a digital recording/playback device with interfaces for additional external audio sources (USB stick, MP3 player, mobile phone audio, etc.). The package can be extended by a Comet S beacon.

PRODUCT BENEFITS AT A GLANCE:

Easy handling by one person:

- storage and transport in a compact and robust protective case
- easy to set up on emergency and unmarked vehicles, intuitive 12-button operation

Independent of the mains power supply

- system is operated via the vehicle's cigarette lighter

Warning:

- standardised warning tones with high penetration implemented
- all-round radiation (360°) or sector sounding (separate: right – left; front – rear)
- optional: Comet S LED beacon in amber or blue

Communication:

- integrated microphone for direct voice announcements, jack socket for importing audio files
- DigiRec digital recording/playback device with an integrated voice memory, expandable via USB stick and audio in endless loops and/or alternation with warning tone



10-year guarantee

MOWACOM 2

Components

1. stackable hard case
2. 744 tone sequence amplifier (integrated in the case)
3. HBE 300 MOW DE hand-held control unit
4. roof unit
5. optional: Comet S beacon (amber or blue)
6. DigiRec (integrated in the case)

AREAS OF APPLICATION:

- civil defence and disaster control
- fire brigades
- municipal services and utilities
- public order offices and authorities
- organisers of major events
- explosive ordinance disposal service

Technical data:	Case	Roof unit
Material:	plastic	stainless steel, plastic
Dimensions W x H x D:	600 x 278 x 400 mm	260 x 170 x 260 mm
Colour:	orange	black
Weight:	12 kg (total weight)	7.2 kg
Voltage:	12 V and 12/24 V	-
Waterproof according to IP67	✓	-
Homologation:		
Light according to ECE-R 65:	TA2 E1 00 4426 TB2 E1 00 4425	COMET S (amber) COMET S (blue)
EMC according to ECE-R 10:	ⓔ1 10R-05 7965 ⓔ1 10R-06 9243 ⓔ1 10R-05 6932 ⓔ1 10R-06 9609	COMET S TFA 744 HBE 300 MOW DE DigiREC



- maximum safety on the runway
- tested in accordance with ICAO type C (more information on page 70)

We also offer warning systems for airport traffic management and escort vehicles, with a range of functions specially designed for use on the runway. Special Hänsch "FOLLOW ME" features ensure quick and easy operation by the user.



ICAO beacons

COMET LED Further information on beacons can be found on pages 9 & 10.

Fix mounting

PRODUCT FEATURES:

- fix mounting according to DIN 14620, form B1
- colours: also available in blue (with function monitoring)
- also available as blue/amber switchable version with flash pattern switching (ECE / ICAO)



Magnetic fixing

PRODUCT FEATURES:

- with spiral cable and triple magnetic fixing
- optimum adhesion, even on curved vehicle roofs
- rubber-coated magnets protect paintwork against scratches
- tested at up to 250 km/h



Flexible tube

PRODUCT FEATURES:

- for fitting on a mounting tube in accordance with DIN 14620
- impact-resistant housing base



COMET S Further information on beacons can be found on pages 5 & 6.

Fix mounting

PRODUCT FEATURES:

- fix mounting according to DIN 14620, form B1
- two rows of LEDs provide full-area illumination
- colours: also available in blue (with function monitoring)



Flexible tube

PRODUCT FEATURES:

- for fitting on a mounting tube in accordance with DIN 14620
- impact-resistant housing base
- two rows of LEDs provide full-area illumination



The DBF 4000 warning system combines the advantages of the DBS 4000 with a range of functions specially designed for use at airports. The system's individually selectable features ensure that traffic management and escort vehicles are optimally equipped for use. The amber DBF 4000 warning system conforms to ICAO type C.



Customisable

- fitted using a modular system
- flexibly adaptable to individual needs
- flash pattern switching possible

Aerodynamic housing

- low wind resistance and reduced noise level

Variety of mounting options

- fast and easy mounting options for flat or curved vehicle roofs
- special vehicle-specific carrier systems offer additional mounting options

Maximum warning effect

- state-of-the-art lighting technology
- automatic day/night switching

Simple control concept

- digital control via the CANBus protocol, based on CiA447 via the HBE 300 Follow Me hand-held control unit

Variety of lengths

- lengths: 1100, 1200, 1400, 1600, 1800 and 2000 mm

DBF 4000

RANGE OF FUNCTIONS AVAILABLE:

- direction indicator
- working lights
- additional flashers
- lighting for the surrounding area (alley lights 20°)
- search light (alley lights 0°)
- full matrix display, amber or red
- printing on the front cover glass
- automatic day/night switching
- also available in a blue/amber switchable version (conforms to ICAO type C).

Further information on page 45.



FOLLOW ME FEATURES:

- LED main beacons with amber or red* high performance LEDs
- rearward directed full matrix with amber or red high performance LEDs and display of the texts "FOLLOW ME", "STOP" and arrows
- possibility to activate the arrows with the vehicle's direction indicator
- brake contact activates the text "STOP"
- control of the lightbar according to CANopen standard 447 with HBE 300 Follow Me digital control unit
- integration of a voice amplifier 614/624 with undercarriage loudspeaker for public address is possible via the HBE 300 Follow Me control unit
- installation of undercarriage loudspeakers possible
- flash pattern switching (between ECE-R 65 and ICAO type C) possible

*if red LEDs are installed, the warning system is not compliant with ICAO type

Technical data:	
Designation:	DBF 4000
Voltage:	12 V
Flash frequency (ECE-R 65):	> 2 Hz (beacon)
flash frequency (ICAO type C)	1 – 1.5 Hz (beacon)
Average power consumption:	from 4 A (at 12 V)
Lengths:	1100, 1200, 1400, 1600, 1800, 2000 mm
Depth:	300 mm
Height:	140 mm
Weight:	from 9.5 kg
Material:	lamp dome/cover glass: PC / housing: aluminium
Type of protection:	IP5K4K / IPX9K
Homologation: (Germany and international)	
Light according to ECE-R 65:	TA2 (E1) 00 3111 (amber)
EMC according to ECE-R 10:	(E1) 10R-05 6209

The DBW 5000 warning system combines modern design, a versatile range of functions and powerful LED lighting technology. A maximum warning effect ensures increased awareness at airports. The minimal installation height not only ensures low drag and a reduced noise level, but also makes it possible to pass under structures with low clearance heights. The amber DBW 5000 warning system conforms to ICAO type C.



reddot award 2017
winner



Customisable

- mounted using a modular system
- flexibly adaptable to individual needs
- flash pattern switching possible

Aerodynamic housing

- low wind resistance and reduced noise level
- low-profile design

Variety of mounting options

- fast and easy mounting options for flat or curved vehicle roofs
- special vehicle-specific carrier systems offer additional mounting options

Maximum warning effect

- state-of-the-art lighting technology
- automatic day/night switching

Simple control concept

- digital control via the CANBus protocol, based on CiA447

Variety of lengths

- lengths: 700, 1100, 1200, 1400, 1600 or 1800 mm

DBW 5000



RANGE OF FUNCTIONS AVAILABLE

- working lights
- lighting for the surrounding area (alley lights 20°)
- search light (alley lights 0°)
- undercarriage loudspeaker for public address
- additional flashers
- direction indicator*
- traffic advisor (special approval required)
- also available in a blue/amber switchable version (conforms to ICAO type C). **Further information on page 36.**
- also available with red radiation colour (without test in accordance with ICAO type C)
- flash pattern switching (between ECE-R 65 and ICAO type C) possible
- automatic day/night switching

*with CiA447, an I/O box for reading the analogue signals is required.

Technical data:	
Designation:	DBW 5000
Voltage:	12 V / 24 V
Flash frequency (ECE-R 65):	> 2 Hz (beacon)
Flash frequency (ICAO type C):	1 – 1.5 Hz (beacon)
Average power consumption:	from 4 A (at 12 V)
Lengths:	700, 1100, 1200, 1400, 1600, 1800 mm
Depth:	285 mm
Height:	63 mm
Weight:	from 5.1 kg
Material:	lamp dome: PC / cover glass: PMMA housing: aluminium
Type of protection:	IP5K4K / IPX9K
Homologation: (Germany and international)	
Light according to ECE-R 65:	TA2 (E1) 00 4448
EMC according to ECE-R 10:	(E1) 10R-05 7981
Direction indicator: light according to ECE-R 6	01 1 (E1) 4453 (front) / 01 2a (E1) 4453 (rear)







HBE 300 Follow Me





The HBE 300 Follow Me version is specially matched to the range of functions of the DBF 4000. It controls all functions of the DBF 4000 visual and acoustic warning system and can also control products that are not CAN-capable.



PRODUCT FEATURES:

- CiA447
- 8 fast access buttons
- 4 menu buttons
- buttons with location and activation lighting
- integrated microphone for public address option
- high-contrast wide-angle display
- easy to operate thanks to large buttons
- convenient menu guidance with self-explanatory icons
- analogue inputs for direction indicator signals from the vehicle
- analogue outputs for additional functions
- usable in any vehicle (even without a 447 gateway)
- various models available

Functions of the fast access buttons (HBE 300)	
	Switches on the main beacons, 3rd beacon and IR flashers. The night-time reduction is activated during operation by pressing and holding the button (>3 sec.).
	Switches the take down display on/off with a request to follow (e.g. "FOLLOW ME") to the rear. An acoustic feedback signal sounds if the text display is active.
	Switches the take down display on/off with a request to stop (e.g. "STOP") to the rear. An acoustic feedback signal sounds if the text display is active.
	Switches the working lights installed at the front on/off. A condition (release signal) may be required or configurable.
	Switches the working lights installed at the left and right on/off. A condition (release signal) may be required or configurable.
Homologation: (Germany and international)	
EMC according to ECE-R 10:	 10R-05 6932

Functions of the menu navigation buttons (HBE 300)	
	Navigate upwards through menu items and functions.
	Navigate downwards through menu items and functions.
	Select and choose menu items and function.
	Return to the previous menu item level. You can also switch off all active functions by pressing and holding this button.

Technical data (without holder tray)	
Weight:	170 g
Dimensions:	66 x 124 x 24 mm (W x H x D)
Voltage:	12 V / 24 V multi-voltage

Cable assembly

We connect your special-purpose vehicle systems

Hänsch has also been supplying complete, customised solutions in the field of system wiring since 2019. From development and design to manufacturing and delivery, we support our customers in integrating the specific wiring harnesses for their special-purpose vehicles. The cable harnesses are designed as ready-to-connect segments. We can look back on many years of experience, primarily in the field of special-purpose vehicle construction. We implement projects purposefully and professionally. This is always done in close cooperation with the customer. Our team supports you from the analysis to the integration into the vehicle.



Contact:

Hänsch Signalconcept GmbH
Potsdamer Strasse 19
14513 Teltow

Tel. +49 (0) 3328 3373 60
info@fg-haensch.de

Everything from a single source

OUR
SERVICE
FOR YOU



AT YOUR SIDE. WITH CERTAINTY.

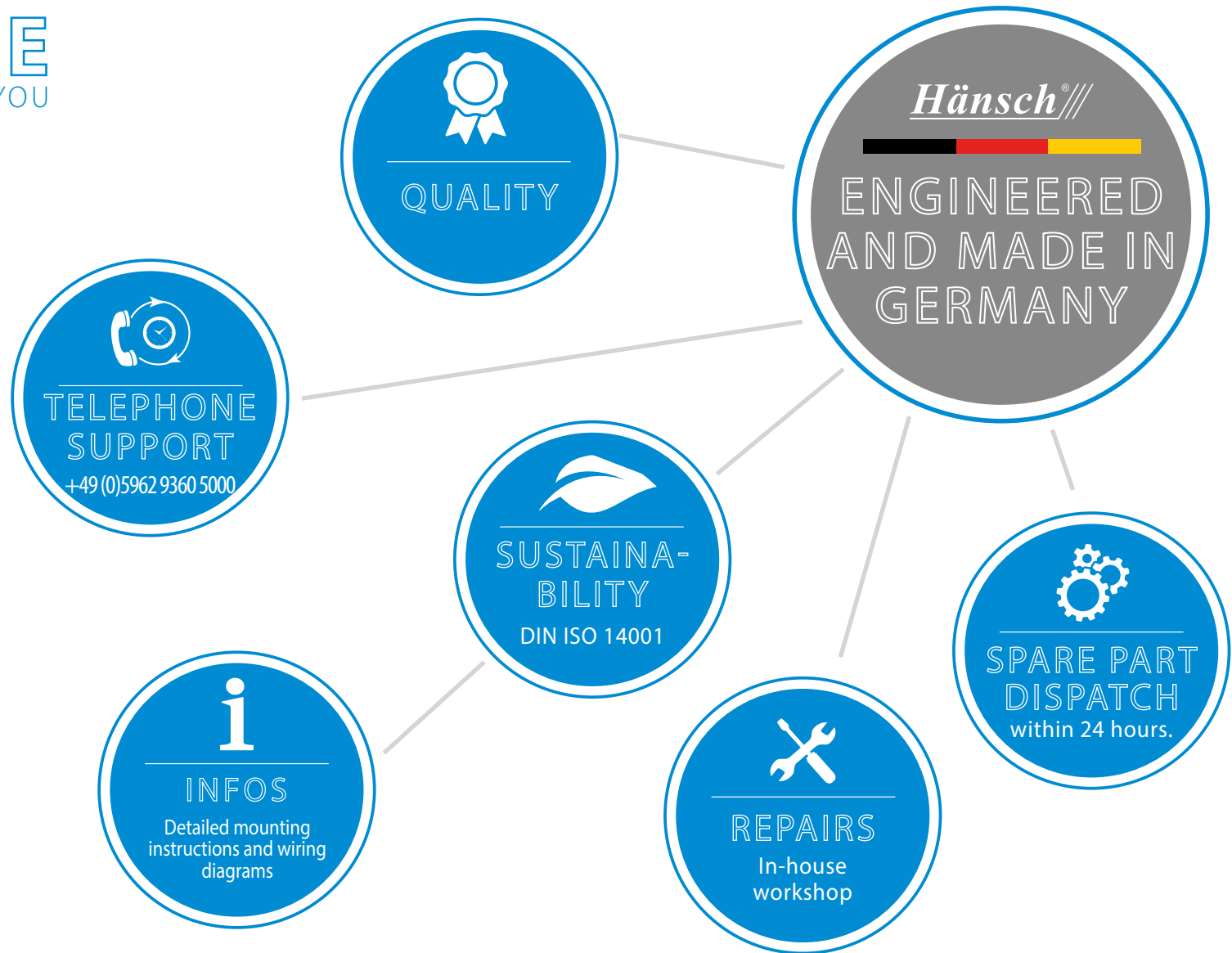

Hänsch

Glossary

ICAO:

The ICAO or EASA standards (European equivalent) are international regulations for technical equipment and devices that may be used at airports.

The products listed here have been tested for compliance with the type C standard. Light values in the range between -3.5° and $+8.5^{\circ}$ as well as a flash frequency in the range of 1 to 1.5 Hz as well as a maximum power of 400 cd are required. The beacons or lightbar systems are not permitted to have day/night switching.

Hänsch products:

Hänsch has tested the following product families in accordance with ICAO type C in the field of beacons and declares their conformity to the standard:

- Comet LED: amber and blue, blue/amber switchable
- Comet S: amber and blue
- DBS/F 4000: amber and blue, blue/amber switchable
- DBS/W 5000: amber and blue, blue/amber switchable

The Comet LED and Comet S single beacons are available in analogue versions, tested in accordance with ICAO type C. The DBS/F 4000 and DBS/F 5000 lightbar systems are only available with CiA447 control. Corresponding ICAO-programmed control units are required for CiA447 control. It is thus possible here to switch between flash patterns in accordance with ICAO type C and ECE-R 65.

Feel free to contact our sales department!

When are HT solutions used?

If the installation of conventional beacons on the vehicle is not possible due to structural conditions, the legally required geometric visibility of 360° can still be achieved by using an HT solution. The HT solution, also referred to as a half-beacon or half lightbar, can be mounted at the front or rear of the vehicle or integrated into the vehicle body. The various solutions, consisting of 2 to 6 HT lamp bodies, allow you maximum flexibility in mounting on the vehicle body. With the Sputnik mini and Sputnik SL HT solutions, installation at the front of the vehicle ensures the earliest possible warning effect, e.g. at intersections or when exiting the depot.

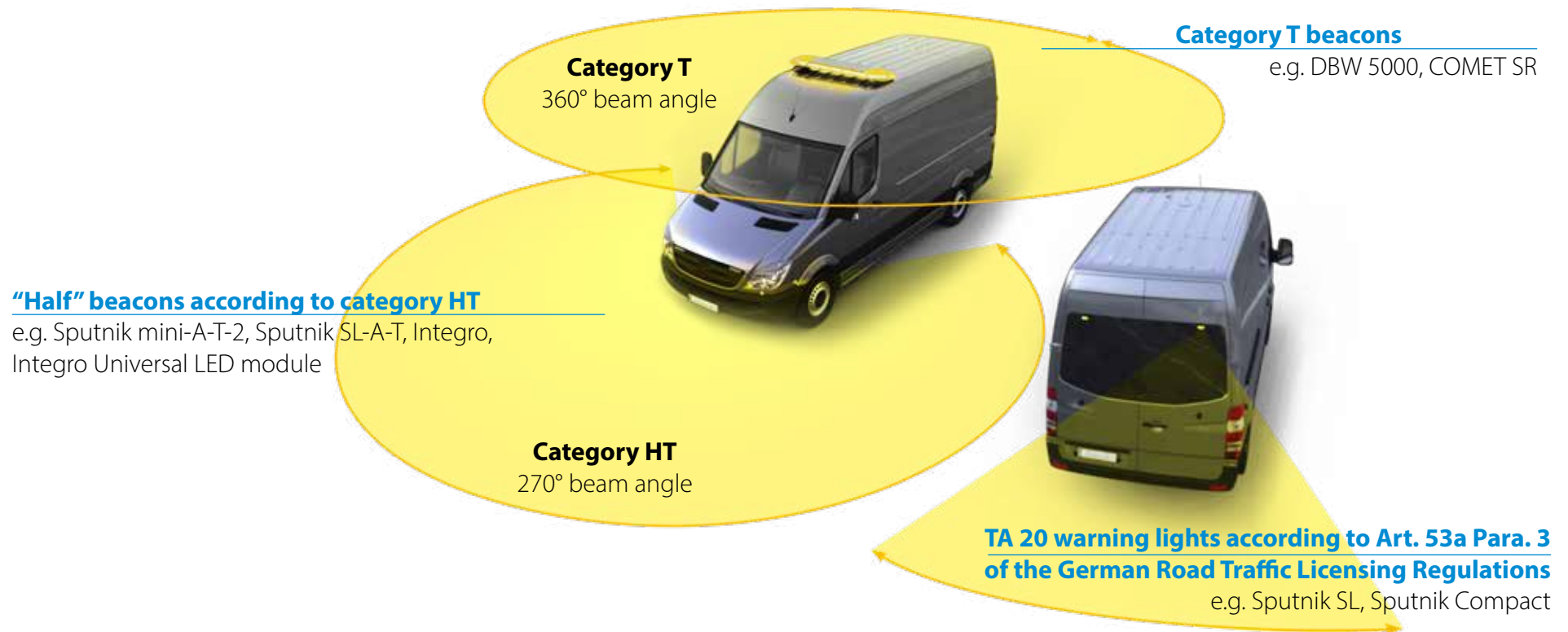

Glossary

Property	Explanation
Function monitoring	Function monitoring allows the operating state of the unit to be checked. The respective operating state can be transmitted by analogue signal line or via the CiA447 bus.
Class II homologation (K2)	The product has a homologation with 2 light intensity levels. The light values can be reduced at night. This is done to prevent glare from excessively high light values at night and/or in case of fog/snow/bad vision.
Day/night switching	Night-time reduction allows products with a class II homologation to reduce the maximum light value either automatically when a defined twilight value is reached, or manually using the control unit (e.g. HBE 300).
Convoy function	The convoy function enables the deactivation of the front- or rear-facing beacons. Some products can also be switched off on one side (e.g. DBS 4000/5000, COMET S). (This prevents convoy drivers ahead or behind from being dazzled).
Soft light signal (night)	Special flash pattern with ECE homologation simulating a rotating beacon, but with simultaneous 360° radiation. Recommended especially for work vehicles so that users can work in a more relaxed manner and for longer periods with less aggressive light.
Rear warning system according to Article 52 Section 11 German Road Traffic Licensing Regulations	The system consists of 2, 4 or 6 directional, amber flash lights of the category X (homologation: XA ...). These are mounted on top at the rear of the vehicle and are used to secure vehicles with blue light when stationary or travelling at walking pace.
12 V	This product has a rated voltage of 12 volts.
12 V / 24 V	This product is available with rated voltages of 12 volts and 24 volts.
12 V / 24 V multi-voltage	This product is multi-voltage-capable and can be operated on both 12 volts and 24 volts.
Analogue	The control of components and functions in the special-purpose vehicle via a discreet analogue level Ub (12 V/24 V) or GND. e.g. via a single switch.
FireCAN	The control of FireCAN components and functions in the special-purpose vehicle via the vendor-neutral CAN-bus standard according to DIN14700.
CiA447	The control of CiA447 components and functions in the special-purpose vehicle via the vendor-neutral CANOpen bus standard CiA447. CiA 447 is a specification of "CAN in Automation e.V." and defines the CANOpen communication for special-purpose vehicles.

Abbr.	Explanation
A	Rigid tube
AF	Flexible tube
B	Fix mounting
BF	Fix mounting with function monitoring
M	Magnetic fixing

Motor vehicle classes:	
M1	Motor vehicle up to 3.5 t and conveyance capacity of up to 9 persons
M2	Motor vehicle up to 5 t and conveyance capacity of more than 9 persons
M3	Motor vehicle over 5 t and conveyance capacity of more than 9 persons
N1	Motor vehicle for goods transport up to 3.5 t
N2	Motor vehicle for goods transport over 3.5 t up to 12 t
N3	Motor vehicle for goods transport over 12 t
N3G	Off-road vehicles

Vehicle classes:	
O1	Trailer up to 0.75 t
O2	Trailer over 0.75 t up to 3.5 t
O3	Trailer over 3.5 t up to 10 t
O4	Trailer over 10 t

Picture credits:

Product photos on the front page and on pages 3-15, 17-21, 23, 25, 27, 31-32, 34, 38-39, 41-43, 46-50, 53-58, 60, 62-67: **Timo Lutz Werbefotografie**
 Photos on pages 4, 16, 26, 61: **MOVIADLED** / pages 2, 24, 33: **Michael Rauch Photographie** / pages 51, 52: **Terex**
 Page 22-23 **photomontage** / pages 22, 42-45, 59, 68, 69, 73: **Hänsch**

Subject to changes and errors.

International Sales Team

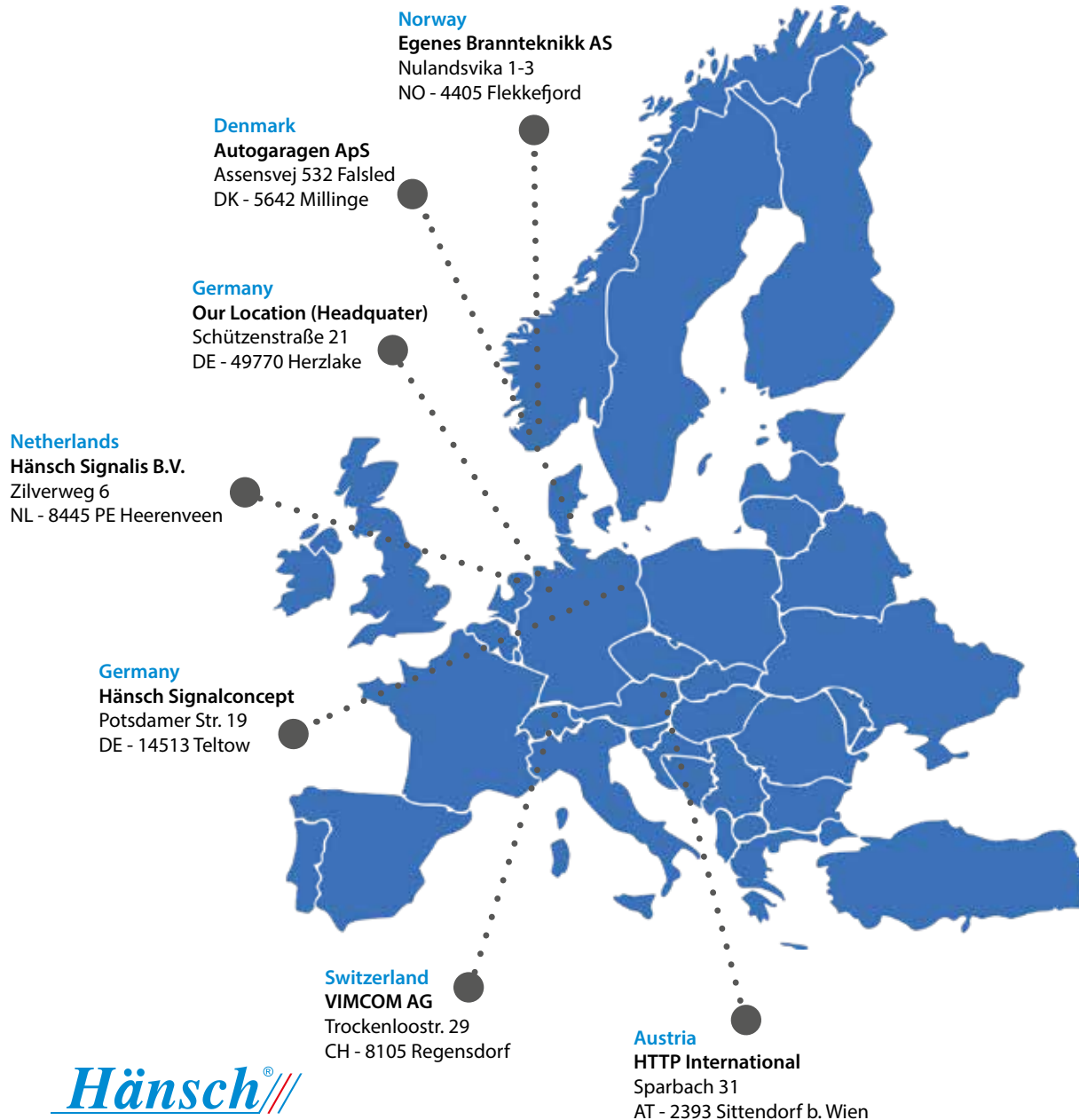

Stefan Fangmeyer
Head of International Sales
Phone: +49 (0) 59 62 93 60 - 938
E-Mail: stefan.fangmeyer@fg-haensch.de



Klaas Reitsma
Sales Manager Hänsch Signalis B.V.
Phone: +31 (0) 513 33 42 - 85
E-Mail: klaas.reitsma@haensch-signalis.nl



Gerrit Hulst
Accountmanager Hänsch Signalis B.V.
Phone: +31 (0) 513 33 42 - 85
E-Mail: gerrit.hulst@haensch-signalis.nl



Stefanie Knue
International Sales
Phone: +49 (0) 5962 9360 - 57
E-Mail: stefanie.knue@fg-haensch.de



Marlen Zwirchmair
International Sales
Phone: +49 (0) 5962 9360 - 923
E-Mail: marlen.zwirchmair@fg-haensch.de



Karin Mross
Business Development
Phone: +49 (0) 5962 93 60 - 936
E-Mail: karin.mross@fg-haensch.de



Melina Koch
International Sales
Phone: +49 (0) 5962 93 60 - 910
E-Mail: melina.koch@fg-haensch.de



WWW.FG-HAENSCH.COM

CATALOGUE FOR AMBER APPLICATIONS
Subject to change
Issue: March 2025

Hänsch[®]///

Schützenstrasse 21
49770 Herzlake
+49 (0) 5962 / 9360-0
sales@fg-haensch.de